



# Z-390 Fazer Machine User Manual



CONFORMS TO  
ANSI/UL STD.998  
CERTIFIED TO  
CAN/CSA STD.  
C22.2 No.104



English • 中文

© 2019 Antari Lighting and Effects Ltd.

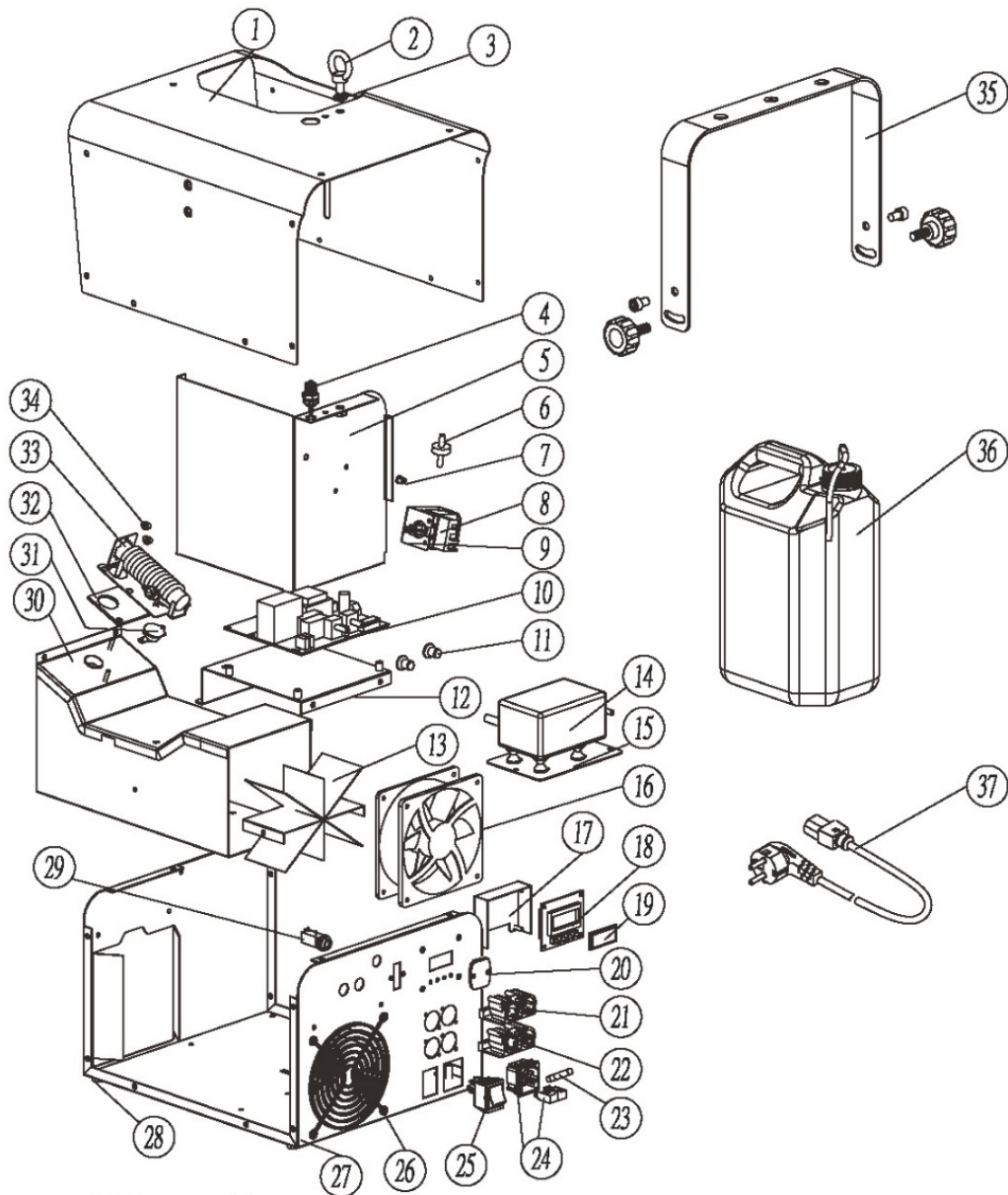

## Z-390 Machine

- |                             |                                      |
|-----------------------------|--------------------------------------|
| ① Steel Case/Cover          | ②① P.C Board(DMX)include 3pin Socket |
| ② Safety Ring M8 Screw      | ②② P.C Board(DMX)include 5pin Socket |
| ③ Washer                    | ②③ Fuse T7A/250V                     |
| ④ Double Side Connect       | ②④ Power Inlet Socket & Fuseholder   |
| ⑤ Steel Case/Partition Base | ②⑤ Rocker Switch/Power               |
| ⑥ Non-return Valve          | ②⑥ Guardrail                         |
| ⑦ LED Base                  | ②⑦ Steel Case/Base                   |
| ⑧ Pump (Group)              | ②⑧ Foot                              |
| ⑨ Pump Steel Base           | ②⑨ Remote Controller Holder          |
| ⑩ PCB Board                 | ③⑩ Steel Case/Vent Base              |
| ⑪ Knob                      | ③⑪ Thermostat                        |
| ⑫ PCB Fix Base              | ③⑫ Heat Insulation Plate             |
| ⑬ Steel Case/Airflow Base   | ③⑬ Heater Group                      |
| ⑭ Air Pump                  | ③⑭ Isolation washer pad              |
| ⑮ Steel Case/Air Pump       | ③⑮ Hanging Bracket(Group)            |
| ⑯ Fan                       | ③⑯ Tank.(Tank's Cap)                 |
| ⑰ Protect Cover             | ③⑰ Cable & Plug                      |
| ⑱ Control P.C Board         |                                      |
| ⑲ L.C.D Cover               |                                      |
| ⑳ Antenna Cover             |                                      |

# Z<sup>390</sup> Series<sup>®</sup>

## User Manual

### Safety Information



Please read the following safety information carefully before operating the machine. This information includes important safeguards about installation, usage, and maintenance. Pay attention to all warning labels and instructions in this manual and printed on the machine.

If you have questions about how to operate the machine safely, please contact your local Antari dealer for help.

- Keep this device dry.
- Always connect to a grounded circuit to avoid risk of electrocution.
- Before connecting the machine to power, always check the voltage indicated on the machine matches to your local AC voltage. Do not use the machine if the AC power voltage does not match.
- Disconnect the machine from AC power before servicing and when not in use.
- This product is for indoor use only! Do not expose to rain or moisture. If fluid is spilled, disconnect AC power and clean with a damp cloth. If fluid is spilled onto electronic parts, immediately unplug the machine and contact your local Antari dealer for advice.
- No user serviceable or modifiable parts inside. Never try to repair this product, an unauthorized technician may cause damage or malfunction to the machine.
- For adult use only. Never leave the machine running unattended.
- Install the machine in a well-ventilated area. Provide at least 50 cm of space around the machine.
- Never add flammable liquid of any kind to the machine.
- Make sure there are no flammable materials close to the machine while operating.
- Only use Antari fluid. Other fluid may lead to heater clogging and malfunction.
- If the machine fails to work, unplug the machine and stop operation immediately. Contact your local Antari dealer for advice.

- Before transporting the machine, make sure the fluid tank is completely drained.
- Fog fluid may present health risks if swallowed. Do not drink fog fluid. Store it securely. In case of eye contact or if fluid is swallowed, immediately seek medical advice.

## Unpacking and Inspection

Immediately upon receiving the machine, carefully unpack the carton, check the content to ensure that all parts are present and have been received in good condition. If any parts appear damaged or mishandled from shipping, notify the shipper immediately and retain the packing material for inspection.

**What is included:**

- 1 x Z-390 Fazer
- 1 x Power Cord
- 1 x User Manual

## Product Dimensions

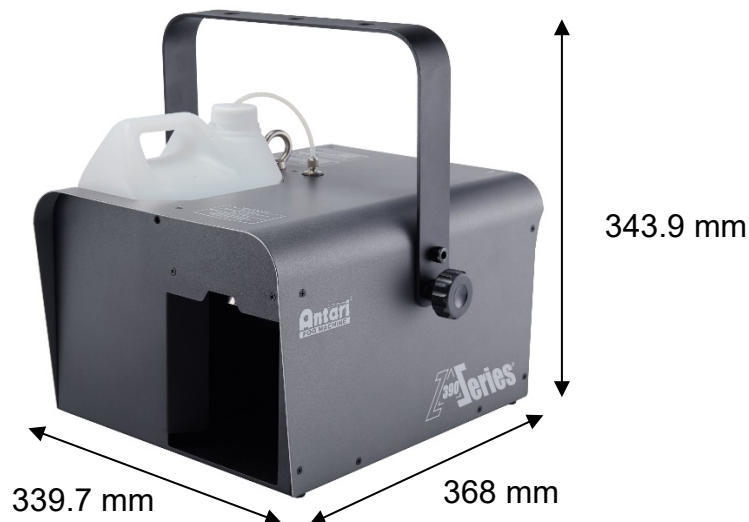

## Product Overview

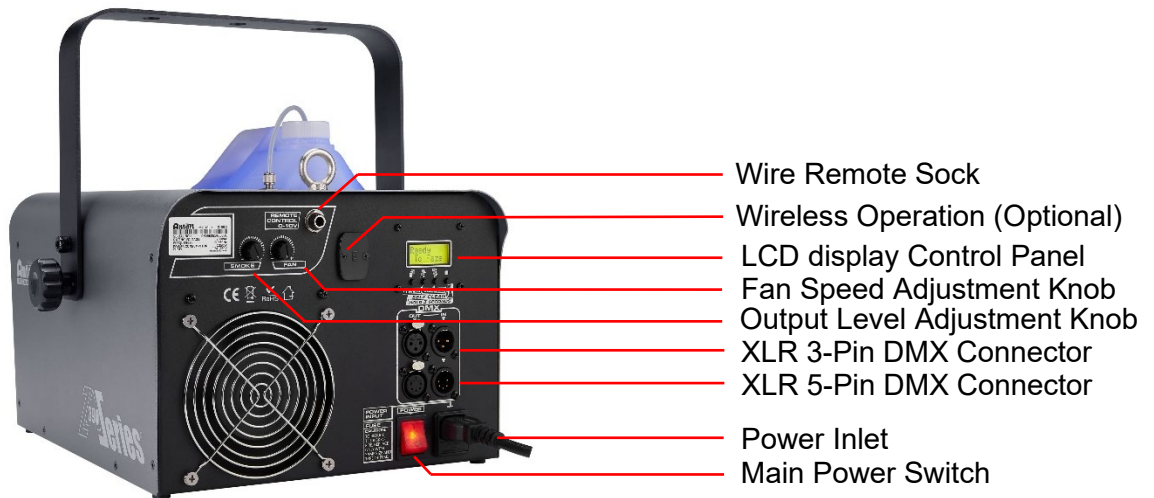

## Setting Up

**Step 1:** Place the machine on a flat surface and in a suitably large area with at least 50 cm of open space around the machine.

**Step 2:** Fill the fluid tank with Antari approved fluid.

**Step 3:** Connect the machine to a suitably rated power supply. To determine the power requirement for the machine refer to the label on the back of the machine.



Always connect the machine to a protected circuit and ensure it is properly grounded to avoid risk of electrocution.

**Step 4:** Turn on the machine and allow it to heat up. Heat up takes approximately 1.5 minutes. Once the machine has reached operating temperature, the LCD display will show "Ready to Faze". Now the machine is ready for operation.

**Step 5:** To start making haze, locate the **Volume** button on the control panel, and press the button to start making faze.

**Step 6:** To turn off the machine, press the **Stop** button and put the power switch to the **OFF** position.

## Operation

### Control Panel Operation

The machine can be operated with the onboard digital control interface or two rotary knobs located on the rear.



Rotary Knob	Function
SMOKE	Turn haze on/off, adjust output volume from 1~100%
FAN	Adjust fan speed from 20%~100%

Button	Function
[MENU]	Scroll through setting menu
▲ [UP]/[TIMER]	Up/Activate Timer function
▼ [DOWN]/[VOLUME]	Down/Activate Volume function
[STOP]	Deactivate Timer/Volume function

### Control Menu

Interval Set 180s	Set the interval from 1 to 180 seconds
Duration Set 120s	Set the duration from 1 to 120 seconds
Timer Out 100%	Set the timer output from 1 to 100%

Volume Out 100%	Set the output volume from 1 to 100%
Fan Out 100%	Set the output volume from 1 to 100%
DMX512 Add. 511	Set the DMX address from 1 to 511
DMX Mode 1Ch	Set the DMX mode Sync, 1Ch or 2Ch
Wireless OFF	Turn On or Off wireless control
Quick Start OFF	Turn On/Off run last setting function
Info Ver: 1.0	Check machine info

### ***Remote Control Operation (Optional)***

To operate the machine by remote control, connect the remote to the microphone jack located on the rear of the machine. Use the switch to turn wind on/off, and use the rotary knob to adjust the output volume from 0~100%.



**WTR-20 Wireless Operation (Optional)**

The wireless remote control system W-2 consists of a transmitter equipped with four buttons to turn faze output on or off, and adjust the output volume; with an onboard receiver attached to the rear panel of the Z-390.



*W-2 Wireless Transmitter*



*Wireless Receiver*

Wireless remote control function:

- [A] button – Turn on faze output
- [B] button – Turn off faze output
- [C] button – Increase output volume
- [D] button – decrease output volume

In an open and unobstructed space the effective distance is 50 meters, usage depending on obstacle level, is 10-25 meters.

**Registering a transmitter**

Transmitters can be paired or deleted from the receiver. Each receiver can pair up to 10 transmitters. Follow below steps to pair or delete a transmitter from a receiver.



Step 1: Set Wireless to ON

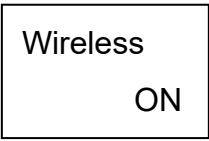

Step 2A: Press [UP] to pair a new transmitter; press any button on the W-2 remote to finish pairing.

Step 2B: Press [DOWN] button to delete existing transmitter.

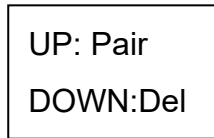

**Transmitter battery replacement**

If the effective distance seems to decrease, it is possible the battery level is low and requires replacement. In order to replace the battery, undo the three screws on the back of the transmitter to release the cover. Replace with same type and specification of battery which is 27A 12V

**DMX Connector Pin Assignment**

The machine provides a 3- or 5-pin XLR connector for DMX connection. The diagram below indicates pin assignment information.

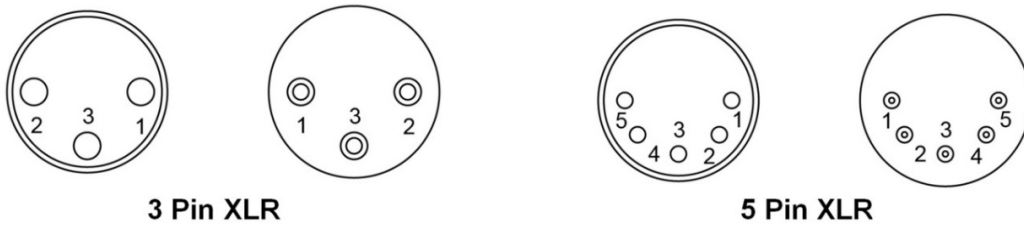

Pin	Function
1	Ground
2	Data-
3	Data+
4	N/A
5	N/A

**DMX Operation**

*Making the DMX Connection* – Connect the machine to a DMX controller or to one of the

machines in the DMX chain. The machine uses a 3-pin or 5-pin XLR connector for DMX connection, the connector are located on the front of the machine.



### DMX Channel Function

Channel Mode	Channel	Value	Function
2	1	0-5	Faze off
		6-255	Faze 1-100%
1	1	0-5	Faze off Fan 100%
		6-255	Faze 1-100% Fan 100%
Sync	1	0-5	Faze Off Fan 20%
		6-255	Faze 1-100% Fan 21 – 100%

## Fluid

Only use Antari FLG water-based liquid for the Z-390 Fazer. The machine is tested and calibrated with this liquid to get the best output performance. Warranty will be voided if any other type of liquid is used, improper use of liquid may lead to machine failure and malfunction.

## Service and Maintenance

- Do not allow the machine to become contaminated.
- Remove dust from the air vents with air compressor, vacuum or a soft brush.

- Only use a damp cloth to clean the casing.
- Before storing run distilled water through the system to help avoid condensing the pump or heater.
- It is recommended to run the machine on a monthly basis in order to achieve best performance and output condition.
- Excessive dust, liquid and dirt built up will degrade performance and cause overheating.

### ***Fuse Replacement***



Disconnect AC power before replacing the fuse. Only replace the fuse with same type and rating.

*Step 1:* Disconnect the power cord from the supply.

*Step 2:* Use a flat-head screwdriver to release the fuse holder.

*Step 3:* Replace the fuse with exact same type and rating as indicated below.

*Step 4:* Reinsert fuse holder.



### ***Fuse***

120V = T10A 250V

240V = T7A 250V

## **Error Messages**

Overheat

Error

Indicates heater exceeds temperature range

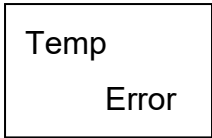

Indicates heater is not working properly

If above message shows on the display, unplug the machine and stop operation immediately. Contact your local Antari dealer for advice

## Technical Specifications

- Input voltage	US model : AC 100-120V, 50 / 60Hz 8.5A EU model : AC 220-240V, 50 / 60Hz 6.5A
- Rated power	1000W (120V) 1500W (240V)
- Warm-up time	1.5 minutes (approx.)
- Fluid consumption	8 ml/min
- Fluid tank capacity	4L (1.06 gallon)
- Compatible fluid	Antari FLG Heavy Fog Fluid
- Operating time	8 hrs at max. output
- Ambient temp. range	0 °C - 40 °C (32 °F-104 °F)
- Control	DMX512, Manual, Timer, Wireless (Optional)
- DMX channels	2 channels
- Connection	IEC (Power), XLR 3-pin and 5-pin (DMX) Z-3 Cable Remote
- Optional accessories	WTR-20 Wireless Remote
- Dimension	L 368 W 277.7 H 267.4 mm ( L 14.49 W 10.93 H 10.53 inch) L 368 W 339.7 H 343.9 (hanging bracket) ( L 14.49 W 10.93 H 13.54 inch) (hanging bracket)
- Weight	9.45 kg (20.83lbs)

# Z<sup>390</sup> Series®

## 中文使用說明手冊

### 使用說明及安全注意事項



在使用機器以前，請仔細閱讀以下說明，此份說明書包含了如何在安全的情況下安裝併使用機器，且會說明機器上所有標示的標籤所代表的意義。

如果您有任何使用上的問題，請連繫當地 **Antari** 經銷商尋求清楚的說明與協助。

- 保持機器的乾燥。
  - 請配合接地型插座，以避免觸電的危險。
  - 使用機器前，請確定使用場所的 **AC** 電源規格，與機器電壓規格是否相符。
  - 拔開機器和 **AC** 電源插座時，請確認機器已關機不在使用的狀態下。
  - 本產品僅限室內使用，請勿將機器暴露在雨中或潮濕的環境，如果有液體(煙霧油)翻倒或溢出，請勿連結機器與 **AC** 電源，用乾布擦拭乾淨，如果任何液體進入機器電子零件，請立即拔除插頭，並連繫當地的 **Antari** 經銷商。
  - 本機器不含任何用戶拆解和自行維修或修改的零件在內，請勿嘗試自行維修或改裝機器，未經授權的技術人員，可能導致機器故障或永久損壞。
  - 機器限成人操作，請勿在無人值守時讓機器運作。
  - 在通風良好的地方安裝使用機器，機器周邊至少應保留 **50** 公分的空間。
  - 請勿添加任何易燃物品進入機器。
  - 操作機器時請確認周邊沒有任何易燃的材料。
  - 為確保機器的使用壽命，請使用 **Antari FLG** 水性煙霧水，添加其他液體可能會導致電熱管阻塞和機器的故障。
  - 如果機器出現故障，請拔下機器插頭，立即停止工作。並請連繫您當地的 **Antari** 經銷商。
  - 運送機器以前，請確認機器的油箱已完全清空。
- 煙霧水不能食用，吞食煙霧水可能導致損壞健康的風險，請將煙霧水存放在室內安全的地方。如果碰觸到眼睛或誤吞食，請立即尋求醫生的協助。

## 包裝內容

在收到機器後，請小心地打開包裝紙箱，檢查所有內容，以確保所有零配件都有齊全收到，並處於良好的狀態。如果有任何部件因運輸過程出現損壞或缺少，請立即連絡經銷商，並以原包裝退回檢查。

內容包括：  
Z-390 輕煙機 1 部  
電源線 1 條  
使用手冊 1 本

## 機器尺寸

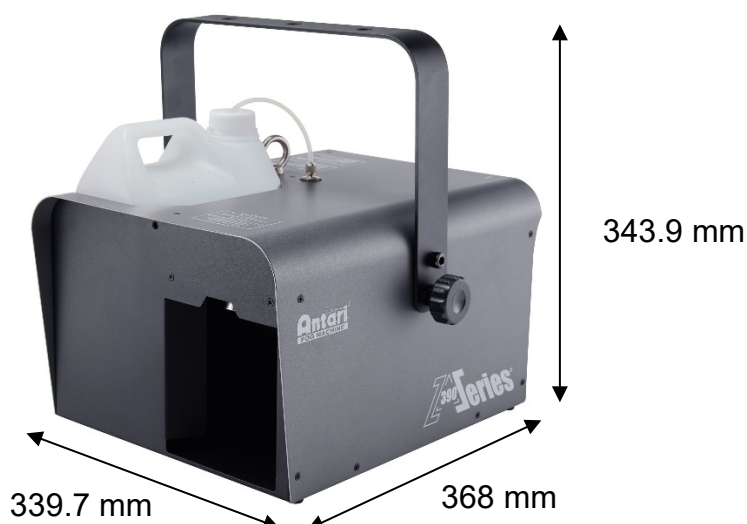

## 機器外觀概述

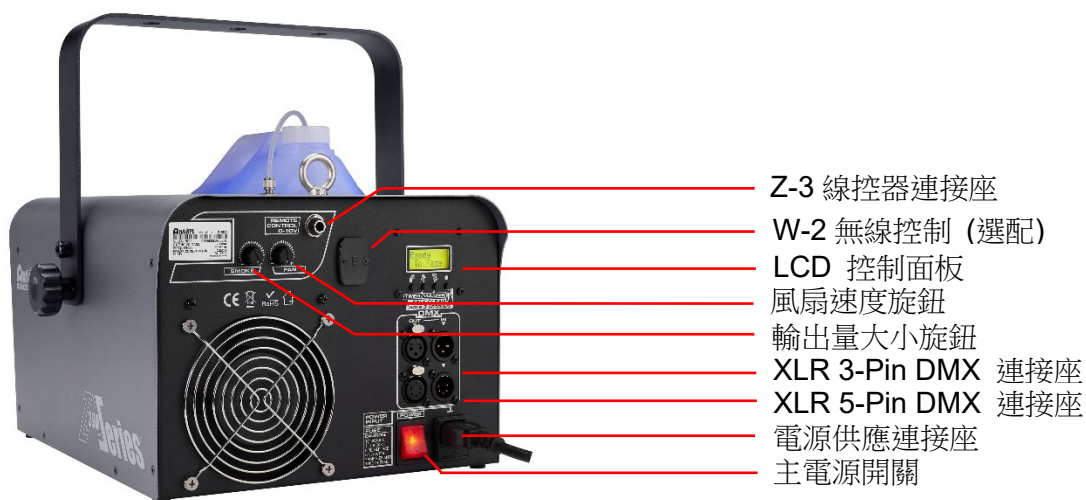

## 設定安裝

**步驟 1:** 將機器平放於平坦的表面，機器周圍至少應保留 50 公分的空間。

**步驟 2:** 將 Antari FLG 濃煙霧水注入機器所附的油桶。

**步驟 3:** 將機器連接電源。連接之前，確認機器背後技術標籤上所標示要求功率，與電源相符。



請務必將機器連結到有保護的電路，並確保有正確地接地，以避免觸電的危險。

**步驟 4:** 啟動機器電源，使機器開始加溫。溫機到工作溫度約需時 1.5 分鐘。一旦機器達到工作溫度，LCD 控制面板會顯示 “Ready to Faze”。表示機器已經準備好並進行操作。

**步驟 5:** 欲開始輸出煙霧，將機器正面控制面板上的 **Volume** 按下開始煙霧輸出。

**步驟 6:** 需關閉本機時，按下 **Stop** 並將主電源開關置於 **OFF** 的位置。

## 操作

### 控制面板操作

Z-390 可透過機器背板上搭載的數位控制面板及 2 個旋鈕操作。

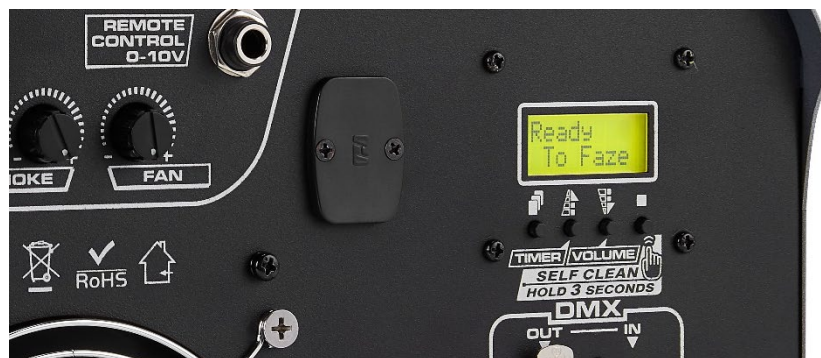

旋鈕	功能
煙量大小	開啟/關閉噴煙，調整煙量從 1~100%
風扇轉速	調整風扇轉速，範圍為 20%~100%

按鈕	功能
[MENU]	瀏覽所有設定清單
▲ [UP]/[TIMER]	增加數值/啟動 定時模式

▼ [DOWN]/[VOLUME] | 減少數值/啟動 輸出量模式

[STOP] | 停止 定時/輸出量模式

---

### 控制清單

Interval Set 180s	設定煙霧輸出間隔，範圍是 1 至 180 秒。
Duration Set 120s	設定煙霧持續輸出時間，範圍是 1 至 120 秒。
Timer Out 100%	設置定時模式下的煙霧輸出量，範圍是 1 至 100%
Volume Out 100%	設置輸出量模式下的煙霧輸出量，範圍是 1 至 100%
Fan Out 100%	設置風扇轉速，範圍是 20 至 100%
DMX512 Add. 511	設置 DMX 位址從 1 to 511 (佔用兩個頻道,煙霧&風扇)
DMX Mode 1Ch	設定 DMX 模式 同步(Sync), 頻道 1 或頻道 2
Wireless OFF	啟動或關閉無線控制功能
Quick StartOFF	啟動或關閉 最後設定的功能



Info

Ver: 1.0

機器規格

頻率、電壓、版本

### **Z-3 控制器操作 (選配)**

使用控制器操作機器時，請將 Z-3 控制器連結位於機器的背面的麥克風插座。使用開/關來啟動煙霧機的輸出功能，使用旋鈕調節輸出量從 0 ~ 100%。



### **WTR-20 無線控制模組 (選配)**

\*W-2 無線發射器

- 發射器：使用 27A 12V 電池
- 接收距離：在無障礙物的開放空間，有效距離為 50 公尺。

實際接收距離根據障礙物多寡，保守距離約為 15-25 公尺。

- W-2 無線發射器配有四個按鈕，可用來啟動、關閉煙霧輸出，調整煙霧輸出量。



W-2 無線發射器

\*無線接收器

- 接收器在經過測試後，會固定在 Z-390 的機器後背板上，請勿嘗試將它拔除。



無線接收器

無線發射器控制功能：

- [A] 按鍵- 開始煙霧輸出
- [B] 按鍵- 關閉煙霧輸出
- [C] 按鍵- 增加煙霧輸出量
- [D] 按鍵- 減少煙霧輸出量

### 發射器對頻

1. 接收器能與發射器對頻及取消對頻
2. 每個接收器可以與 10 組發射器對頻
3. 請按照以下步驟來取消與對頻無線發射器

步驟 1: 選單內切換到

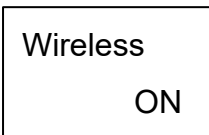

步驟 2A: 按 [UP / 箭頭向上]按鍵對頻新的發射器，按下 W-2 無線控制器上的任何按鍵來完成對頻。

步驟 2B: 按 [DOWN / 箭頭向下]按鍵來刪除現已對頻之發射器。

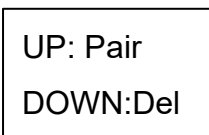

### 更換 W-2 無線發射器電池

如果無線控制器的有效控制距離縮短，可能是電池的電力不足，需要更換。請將 W-2 發射器背後的三個螺絲旋開，打開背蓋，使用同樣是 27A/12V 的電池更換。

### DMX 連接 PIN 的接點說明

本機可提供 3 Pin 或 5 Pin XLR 的 DMX 連接選擇。下方為 Pin 的接點說明：

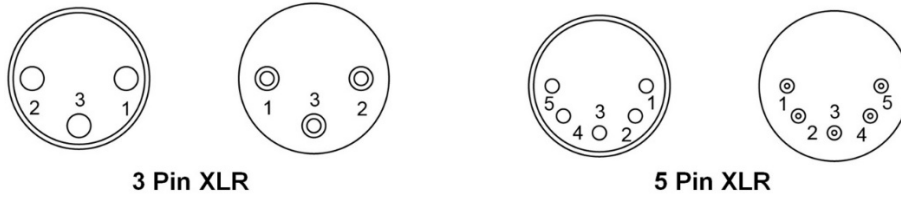

Pin	功能
1	接地
2	數據-
3	數據+

### DMX 操作

建立 DMX 連接 – 將機器連接到 DMX 控制器或 DMX 鏈中的機器之一。本機提供 3 Pin 或 5 Pin XLR 的 DMX 連接選擇，該連接器位於機器的背面右側。



### DMX 通道功能

通道模式	頻道	DMX 數值範圍	功能
2	1	0-5	關閉煙霧輸出
	1	6-255	煙霧輸出 1-100%
1	2	6-255	風扇 20-100%
	1	0-5	關閉風扇輸出
1		6-255	風扇 100%
	同步(Sync)	1	0-5
6-255			風扇輸出 100%
同步(Sync)	1	0-5	關閉煙霧輸出
		6-255	風扇輸出 20%
同步(Sync)	1	0-5	煙霧輸出 1-100%
		6-255	風扇輸出 21-100%

## 煙油的使用

Z-390 輕煙機，僅能使用 Antari FLG 高品質濃煙霧水。機器使用 FLG 高品質濃煙霧水進行測試與校正，使用 FLG 煙霧水將產生最佳的煙霧效果。使用其它的煙霧水，將導致機器故障並保固失效。

## 維修保養

- 請保持機器清潔，不要讓機器髒汙。
- 可以使用空氣壓縮機，吸塵器或軟毛刷除去機器上的灰塵。
- 機殼可使用濕布擦拭。
- 存放或收起機器前，請確認機器完全冷卻，以避免幫浦或加電熱管產生冷凝。
- 建議每月至少讓機器溫機並運轉一次，以保持機器處於最佳的性能和輸出條件。
- 機器上過多的灰塵，液體殘餘累積的髒污會降低機器工作性能，並導致散熱不良。

### 更換保險絲



更換保險絲前關閉電源。並限使用相同類型和等級的保險絲。

步驟 1: 關閉電源

步驟 2: 使用平頭螺絲刀鬆開保險絲座

步驟 3: 更換相同類型和等級的保險絲如下所示

步驟 4: 將保險絲座裝回



### 保險絲規格

120V = T10A 250V

240V = T7A 250V

## 機器錯誤訊息

Overheat  
Error

機器偵測電熱管過熱。

Temp  
Error

電熱管無法正常運作。

若控制面板顯示以上訊息，請立即將電源拔除並停止操作機器。請與當地 **Antari** 經銷商/零售商連絡，尋求協助。

## 規格資料

電壓	美規 : AC 100-120V, 50 / 60Hz 8.5A 歐規 : AC 220-240V, 50 / 60Hz 6.5A
額定功率	120V 1000 瓦 240V 1500 瓦
加熱時間	(約) 1.5 分鐘
耗油量	8 毫升/分鐘
油桶容量	4 公升
運作時間	8 小時 (最大輸出量下)
使用煙油	Antari FLG 濃煙霧水
控制方式	DMX 512, 有線控制器, 手動控制, 無線發射器(選配) 可調節煙霧輸出量和風扇轉速
DMX512 頻道	本機占用 2 頻道, 煙霧輸出量與風扇轉速
連接座	IEC (主電源)
DMX 數據連接座	3 pin 和 5 pin XLR 連接座
控制器連接座	3.5mm 麥克風插座
選擇性配件	Z-3 有線控制器, WTR-20 無線控制模組
外型尺寸	長 368 x 寬 277.7 x 高 267.4 mm 長 368 x 寬 339.7 x 高 343.9 mm (含吊架)
淨重	9.45 公斤 (20.83 磅)







For current product information visit Antari at: [www.antari.com](http://www.antari.com)  
For information requests please contact us at: [sales@antari.com](mailto:sales@antari.com)



C08Z39000

[www.antari.com](http://www.antari.com)